

PLAN VIEW
RIGHT HINGE
SELECT

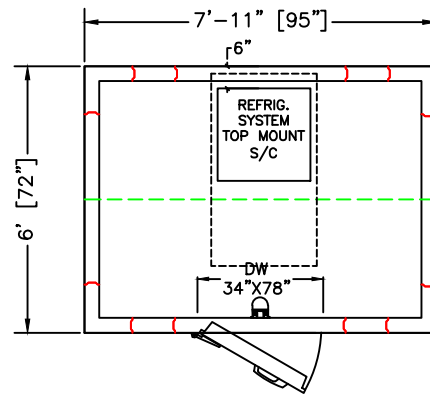

PLAN VIEW
LEFT HINGE
SELECT

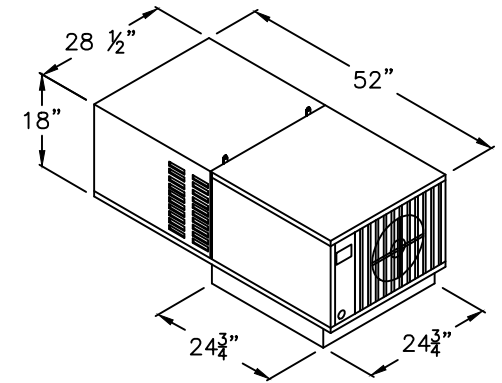
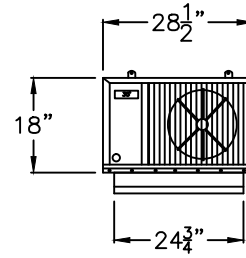

REFRIGERATION UNIT

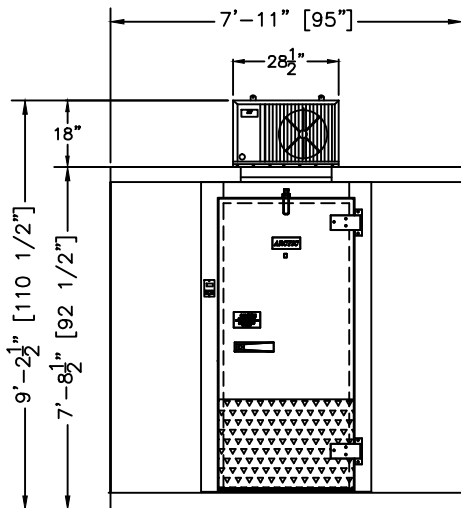

ELEVATION
RIGHT HINGE

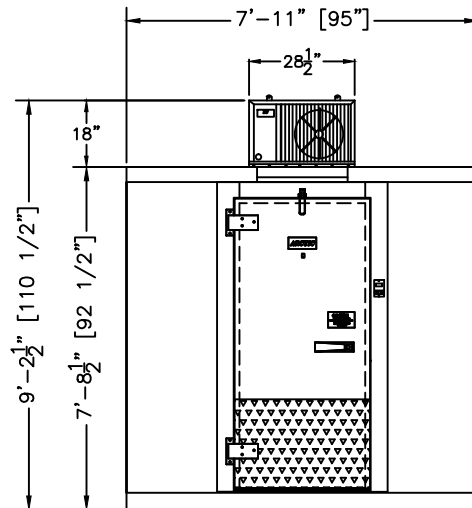

ELEVATION
LEFT HINGE

PRODUCT SPECIFICATIONS	
MODEL:	BL86-CF-SC
WALK-IN SPECIFICATION	
INTERIOR/EXTERIOR FINISH	26 GAUGE MILL EMBOSSED ACRYLUME OR 26 GAUGE STUCCO EMBOSSED GALVANIZED STEEL
ELECTRICAL (VOLTS/Hz/PH)	115/60/1
MAX AMP.	0.8
SYSTEM SPECIFICATION	
ELECTRICAL (VOLTS/Hz/PH)	115/60/1
AMPS	20
WEIGHT (LBS)	210
CORD + NEMA 5-20R PLUG	
WALK-IN AND REFRIGERATION FREIGHT	
TOTAL SHIPPING WEIGHT (LBS)	1065
MAXIMUM PALLET SIZE	48" X 96" X 102" HIGH
NUMBERS OF PALLETS	2

MODEL: BL86-CF-SC

INDOOR-WITH FLOOR

COOLER 35°F

SELF-CONTAINED SYSTEM

CUSTOMER APPROVAL

DATE: _____

SIGNATURE: _____

CONFIDENTIAL

THE DRAWINGS, TECHNICAL DATA, AND ALL OTHER INFORMATION SET FORTH IN THIS DOCUMENT COMPRISE TRADE SECRETS AND CONFIDENTIAL INFORMATION THAT IS THE EXCLUSIVE PROPERTY OF ARCTIC INDUSTRIES, LLC.

USE OF SUCH INFORMATION IS LIMITED TO THE PURPOSE FOR WHICH IT WAS PROVIDED AND NO RECIPIENT IS PERMITTED TO USE, COPY, OR DISCLOSE SUCH INFORMATION EXCEPT AS EXPRESSLY AUTHORIZED BY ARCTIC INDUSTRIES, LLC.



WALK-IN COOLERS AND FREEZERS
9731 N.W. 114th WAY
MIAMI, FL 33178
PHONE: (305) 883-5581
www.arcticwalkins.com

